

The Light

User manual

460

Eng

CE

Contents

Thank you for purchasing The Light.

The instructions described below have been designed to provide necessary information for successful operation, daily maintenance and safety for use of this unit.

Introduction	01
- Introduction	
- Contents	
- Features	
- Application	
1. Safety Information	03
- Symbols	
- Notes and reference	
- Installation and Connection	
- Operation	
- Maintenance	
2. List of Components	07
3. Parts and Functions	08
4. Installation and Connection	09
5. Direction for Use	11
6. Selection of Curing Modes	12
7. Maintenance	13
- Cleaning and sterilization	
- Maintenance and replacement of the Battery	
8. Trouble Shooting	14
9. Specification	15
10. Accessories	16
11. Warranty	16

Features

Features

- Variety of curing modes
- Easy-to read OLED screen
- Enhanced capacity battery
- Lithium-ion battery
- Interchangeable lithium-ion battery
- Chargeable battery alone
- Automatic sleep mode

Application

- Polymerization of light-cure catalyst containing dental materials with a wavelength spectrum of 440 ~ 490 nm.

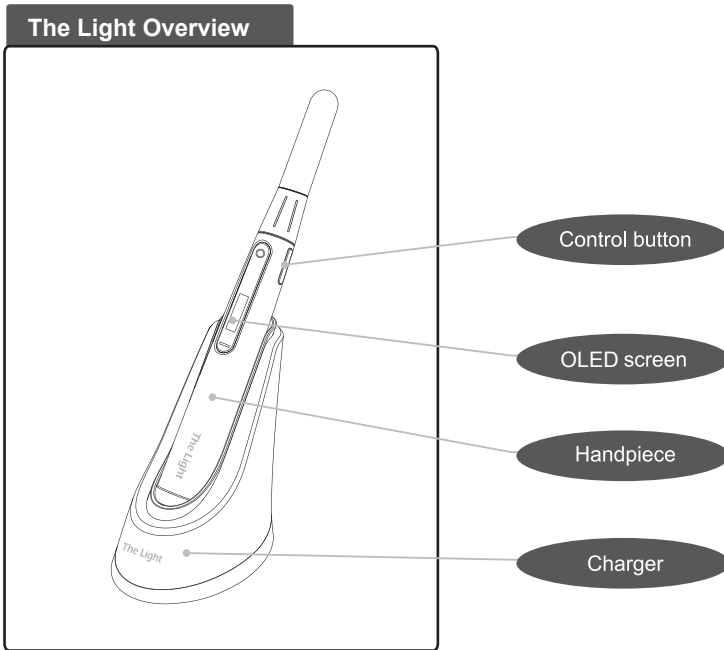

1. Safety information

It is important to understand the following information to use this product safely.

Symbols



Warning

Indicates a potentially hazardous situation which, if not avoided, may result in serious injury or death.



Caution

Indicates a potentially hazardous situation which, if not avoided, may result in minor/moderate injury or in damage of property

Notes and References

Notes and References used in this manual are shown below.



Note

Indicates that potential malfunctions may occur if the description is ignored.



Reference

Supplementary information to facilitate better operation.

Installation and Connection



Warning

- The adaptor should be disconnected from the charger before connecting the power cable to prevent an electric shock.
- Keep away from sources of ignition to avoid fire or explosion.
- Protect the handpiece, charger, and battery from any liquid to avoid electric shock or functional error.
- Place the charger on a flat and stable surface. Do not drop handpiece or charger in order to avoid internal defect that may cause overheating or fire.
- Do not place the electrical cord near a gas burner or sources of heat.
Should the cord catch on fire, replace with a new one to avoid short-circuit.



Caution

- Do not use or leave the unit in areas of high temperature or exposed to direct sunlight; internal circuit defect may cause overheating or fire.
- Securely connect the dust-free power plug to the outlet.
Use this device in well ventilated areas. Overheating may cause fire.
- Do not touch the terminal areas of charger or battery with fingers or conductive objects, such as metal wire or safety-pin. It may cause electric shock or fire.
- Do not use any charger other than supplied. It may result in electric shock or fire.



Warning

- Do not plug the power cord with wet hands. This may result in an electric shock.
- In case of fluid leak from battery or partial discoloration/deformation of the handpiece, immediately discontinue use.
- Place the battery in correct direction when charging. Wrong directed placement may cause malfunction, explosion, or fire.
- In case of partial discoloration of the charger, immediately disconnect the power plug and repair the charger.
- In case battery fluid contacts the eye, immediately flush with copious amount of clean water and seek medical attention.
- Do not use this product on patients with a history of cataract, retinal damage or allergic reaction to light.
- Do not use this product on a person with a pacemaker as it may cause malfunction of the pacemaker.
- Avoid exposing the light on intraoral soft tissue as it may affect the soft tissue.
- Do not put the battery on the charger upside down. This may cause an explosion or fire.



Caution

- Disconnect the power cord by grasping the power plug to avoid injuries or burns.
- Avoid damage or use of unnecessary force on the power cord. This may cause an electric shock or fire.
- Should battery fluid contact the skin or clothes, immediately wash it off with copious amounts of water to avoid skin damage.
- Take the battery out of the handpiece if it won't be used for more than 1 week.
- Connect the power plug only when battery is being charged. Insulation degradation may cause electric shock or fire.
- Do not use this product for any purposes other than dental use.

Maintenance



Warning

- Use only the battery supplied to avoid fluid leak or explosion.
- Never disassemble or overhaul the product. Unusual performance may cause injuries, electric shock, or fire.
- Ensure that charger and battery are always separated from the handpiece prior to cleaning.



Caution

- If the OLED screen malfunctions, remove the battery from the handpiece and reinsert it.

2. List of components

Please check the contents described below when removing the contents from the original packaging.

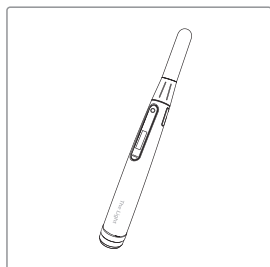

Handpiece

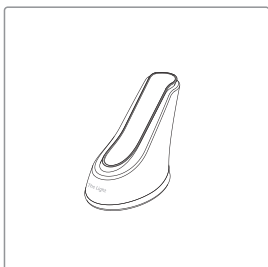

Charger

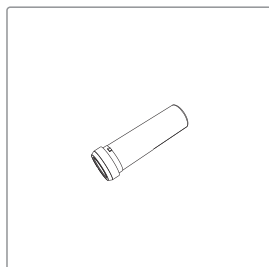

Battery

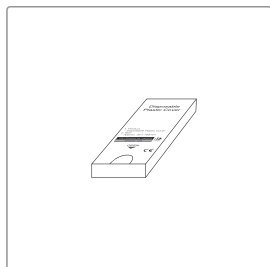

Disposable cover
(Approx.100pcs)

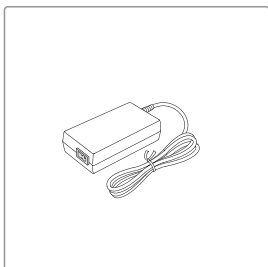

Adapter

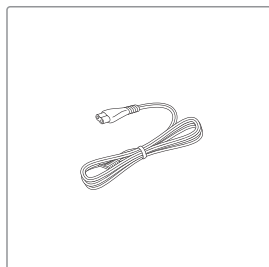

Power cable

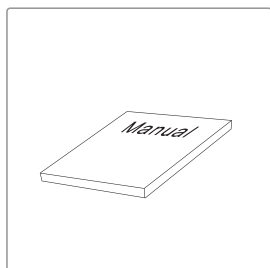

User manual

3. Parts and Functions

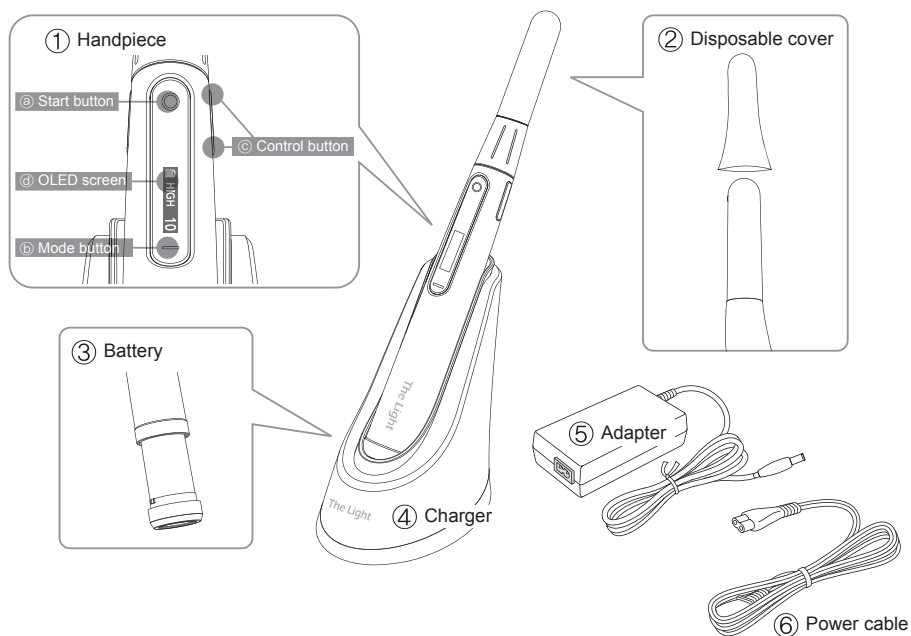

① Handpiece

- a Start button : Operation and Turn On/Off
- b Mode button : Curing mode select
- c Control button : Curing time select
- d OLED screen : Display device state

② Disposable cover (Approx.100pcs)

③ Battery

④ Charger : Charge battery. Display charging process

⑤ Adapter

⑥ Power cable

4. Installation and Connection

Refer to the information supplied on safety precautions during installation and connection.

1. Connection between Adapter and Charger

- 1) Securely insert the power cable with 100~240V power outlet.
- 2) Connect power cable with adapter.
- 3) Connect adapter with charger

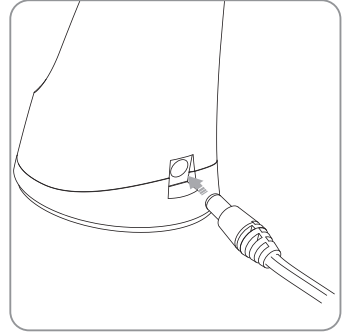

Note

- Use only the original adapter supplied.
- When the adapter is connected with charger, red and blue light will blink.
- If red and blue light is not blinking when adapter is connected, it is a charger malfunction.

2. Inserting Battery

- ① Carefully insert the battery into the handpiece as directed by the arrow.
 - ② The battery turns with the arrow, as seen in image.
- *Avoid forcing the Battery.

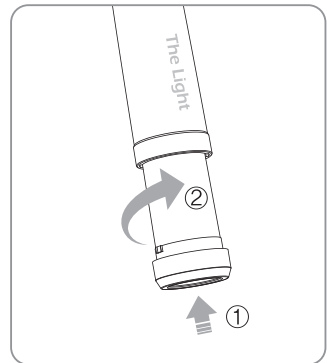

4. Installation and Connection

3. Charging

- Insert the handpiece into the vertical slot at the front of the charger.
- Red light on : charging in progress
- Blue light on : charging process is complete

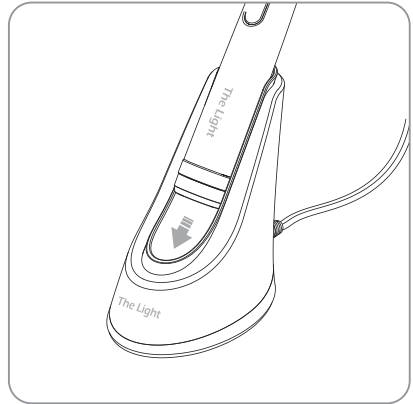

Note

- If the remaining battery is extremely low, red light may flicker while recharging, which is not a malfunction.



Reference

- It will take approximately 3~4 hours before the battery will be fully charged.

5. Direction for Use

1. Activating Handpiece

- 1) Press any button, then OLED screen will be on standby mode and time display used last.

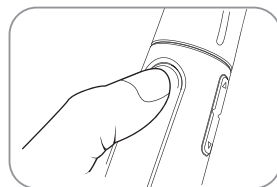

- 2) Select curing mode and time setting with mode button and control button.

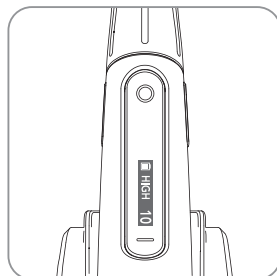

Initial Screen



Standby Screen
(last used mode & time)



Reference

- When Battery inserted, the unit is automatically turned on.

2. Start of exposure

Press Start button to start exposure with the selected mode.



Reference

- Press any button if you wish to end the curing process.
- Alarm during operating informs time passage.

3. Battery icon

This icon indicates the power remaining in the battery. Recharge or replace the battery when "LOW BATTERY" sign appears on the display screen.



Reference

- Sleep Mode : If unit is left unused for a few minutes, all functions are automatically transferred to sleep mode with a short beep. Hold down start button for approximately 3-5 seconds to shut off light. If you want to turn on, press any button.
- Set-up memory : The handpiece will record the setting used last.

6. Selection of Curing Mode

Curing mode can be set by pressing the mode button.
Various curing programs are available in this unit.

1. High Mode

Time setting: 5, 10 sec.

Quick polymerizing with high intensity
Intensity is more than $1,500\text{mW}/\text{cm}^2$

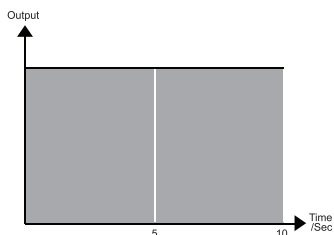

2. Low Mode

Time setting: 10, 20, 30 sec.

Polymerizing with low intensity
Intensity is more than $650\text{mW}/\text{cm}^2$

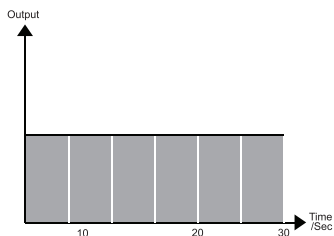

3. Soft Start Mode

Time setting: 20 sec. (fixed)

Special mode to avoid polymerization shrinkage
Intensity is 0 to $1,500\text{mW}/\text{cm}^2$

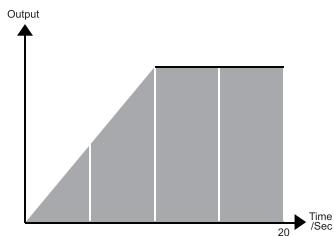

4. Pulse Mode

Time Setting: 10, 20 sec.

Special mode to avoid polymerization shrinkage
Intensity is 0 & $1,500\text{mW}/\text{cm}^2$

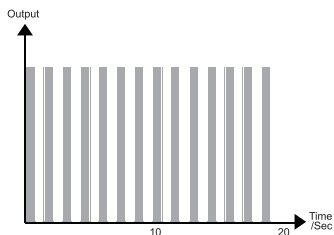

7. Maintenance

Cleaning and disinfection

- Clean the handpiece and charger gently with clean, soft, lint-free cloth.
- Avoid using solvents which contain ethanol or acetone.
- Do not use sharp or pointed tools to clean as they may damage or scratch the plastic.
- Be careful not to spill any liquid into the device.

Maintenance and replacement of the battery

- Exposure to high room temperature may shorten the battery life and affect device performance. Use the device in normal temperature.
- It is recommended for rechargeable battery to be charged immediately before use to maximize efficiency.
- Remove the battery from the handpiece, if not being used for a long time.
- If the running time declines with a full-charged battery, replace the battery before use.

8. Trouble Shooting

If your curing light unit is not operating normally, please refer to the following points.

	Trouble	Cause and Solution
1	Control button does not work	If the control button is pressed with excess force, it will not work. In such case press the button gently.
2	Display screen does not work	If the battery is completely discharged or connected incorrectly, display will not appear. Recharge the battery or reconnect the battery to reset the device.
3	Power off while in operation	If the start button is pressed for a moment, power will be turned off. Press any button again. Check the battery connection again. If the battery is completely discharged, device can be turned off. Recharge the battery.
4	Not able to charge	If the power cord or etc. is not correctly connected, the battery can not be charged. If the battery or handpiece is not properly placed on the charger, the battery can not be charged.

* If the trouble is not settled after the above solutions, please contact GC America Inc. Customer Service.
(Phone: 800-323-7063)

9. Specification

Handpiece	Operation voltage	3.7 V
	Wavelength range	440 ~ 490 nm
	Dimensions (included Battery)	Approx. 232 x 26 x 26 mm
	Weight (included Battery)	Approx. 130 g

Charger	Operation voltage	5 V
	Dimensions	Approx. 110 x 105 x 68 mm
	Weight	Approx. 100 g

Battery	Type	Lithium Ion Battery
	Nominal Voltage	DC 3.7 V
	Dimensions	Approx. 75 x 25 x 25 mm
	Weight	Approx. 52 g

Disposable cover	Dimensions	Approx. 32 x 100 mm
	Quantity	Approx. 100 pcs by weight

Adapter	Input voltage	AC 100 ~ 240 V
	Output voltage	DC 5V
	UL number	E333054

* This specification is subject to change without prior notice

	Model name	CL-DC20
	510(k) number	K093751

10. Accessories

- Disposable cover (Approx.100pcs)
- Battery

11. Warranty

This product is shipped after strict inspection. Should the product have any problem under normal usage within one year from the date of purchase, repair will be free of charge.

However, repair of consumables (disposable cover, battery, etc.) are not covered by the warranty. For more information, refer to the warranty card attached.

Serial number check.

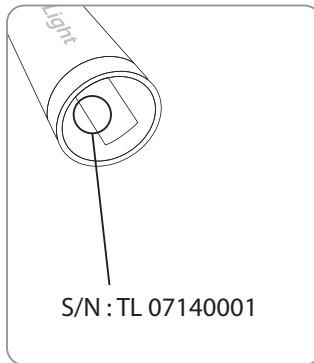
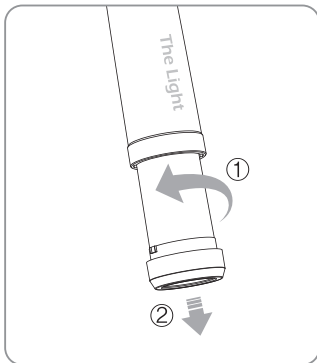

EC REP Gruneworld GmbH
Georg-Weiss-Weg 9, 53125 Bonn, Germany
TEL: +49(0)288/7077695 FAX: +49(0)288/7077696
Website: www.gooddrs.de

 Good Doctors Co., Ltd.
#208, B-Dong, 283 Bupyeong-daero, Bupyeong-gu,
Incheon, Korea (Woolim Lions Valley, Cheongcheon-dong)
(Zip code : 403-911)
Tel : + 82 32 424 6325 Fax : + 82 32 424 6326
E-mail : info@gooddrs.com Website : www.gooddrs.com

The Light LED Curing Light Warranty and Repair Process – USA and Canada

WARRANTY FOR ONE YEAR FROM DATE OF PURCHASE

In order to remain eligible for your warranty, you **MUST** complete this warranty/registration information and return it to GC America at the address below or fax number within 20 days of purchase.

1. If The Light LED Curing Light has a material or manufacturing defect during the one-year warranty period, call GC Customer Service at: 1-800-323-7063.
2. Provide all necessary information to Customer Service (e.g. detailed fault description, serial number, address information, proof of warranty, copy of invoice).
3. After Customer Service confirms this is a warranty issue, return the apparatus in suitable packaging to GC America at the address below.
4. Customer must include a copy of the invoice, contact information and details of the problem.
5. Customer Service will notify the customer when the product has been received and the date that the replacement product will be shipped.

GC America • Attn: Customer Service, The Light Return • 3737 W. 127th Street • Alsip, IL 60803 • Fax: 708.371.5103

-
1. Dr. Mr. Mrs. Ms. Miss
- First Name _____ Middle Initial _____ Last Name _____
- Address _____ Suite # _____
- City _____ State _____ Zip Code _____
2. E-mail Address _____
3. Years in practice _____ 4. Office Phone # _____
5. Date of purchase _____ 6. Model # _____
7. Serial # _____ 8. Dealer product purchased through _____
9. Dealer invoice date _____ 10. Dealer invoice # _____
11. Light Purchased: The Light The Light 405

(Please turn to the back page to complete the remainder of this form)

You can also fill out this information online at: http://www.gcamerica.com/warrantyandregistration/the_light



12. What were the most important factors that influenced your selection of this product?

- Trust in GC Online Research Quality Warranty Dealer
 Promotional Price Size Ease of operation Appearance/design Features
 Colleague recommendation If other, please specify _____

13. What other brand(s) did you seriously consider before selecting The Light?

- Radii Demi Plus/Ultra Bluephase CotoLux Elipar S10
 If other, please specify _____

14. How many chairs are in your practice? _____

15. When new products that have the latest technologies appear on the market, do you or someone in your practice:

- Tend to buy such items as soon as they are available?
 Tend to wait until the item has been around for a while before buying?

16. To help us understand our customers' practices, please fill in the blanks below:

What brand of composite/flowable composite do you use? _____

What brand of bonding agent do you use? _____

What brand of resin cement do you use? _____

What brand of impression material do you use? _____

17. How many doctors are in your practice? _____

18. How many hygienists are in your practice? _____

- Please check here if you do not want to receive mailings and offers from GC America using your e-mail address related to your interest above.

Thank you for participating in this questionnaire.

Your answers will be used for market research studies and reports. GC America will not sell your data.

Please send any correspondence about our product to: GC America • 3737 W. 127th Street • Alsip, IL 60803

You can also fill out this information online at: http://www.gcamerica.com/warrantyandregistration/the_light



Distributed in the US & Canada by

GC America Inc.
3737 West 127th Street
Alsip IL 60803
Phone: 800-323-7063
Fax: 800-GCFAXME
Website: www.gcamerica.com

Good Drs
<http://www.gooddrs.com>

Rev.0

Good Doctors Co., Ltd.

Address. #208, B-Dong, 283 Bupyeong-daero, Bupyeong-gu, Incheon, Korea (Woolim Lions Valley, Cheongcheon-dong) (Zip code : 403-911)
Tel. +82-32-424-6325 Fax. +82-32-424-6326 Website. www.gooddrs.com E-mail. sales@gooddrs.com / info@gooddrs.com